



Model Name	AC1800S36D
Output Mode	Constant Current
Input Voltage	120-277 Vac
Input Frequency	50/60 Hz
Dimming	3 in 1 (PWM, 1-10V, Resistance) Dimming: 1-100%
Surge Rating	2KV
Warranty	5 Years $TC \leq 75^{\circ}C$ 3 Years $75^{\circ}C \leq TC \leq 90^{\circ}C$

Product Specification



Output Power (W)	Output Voltage (V)	Output Current (A)	Start Temp. ($^{\circ}F/^{\circ}C$)	Tcase Temp. ($^{\circ}F/^{\circ}C$)	Input Current (A)	Input Power (W)	Inrush Current (A)	THD (%)	Power Factor	Efficiency (%)
Max. 36	12-20	1.8	Min -40/-40	Max. 194/90	0.41@120V 0.18@277V	41	Max. 30	Max. 20	Min. 0.9	Typ. 87

Wire Diagram

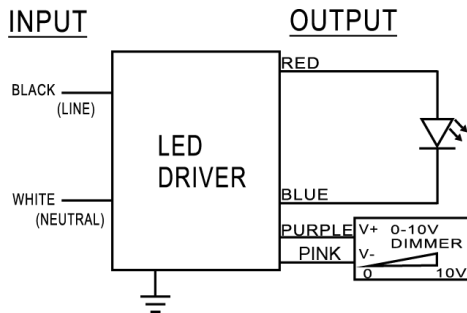

Maximum Wiring Distance (at full load) is 18AWG/18Feet

LED case should be grounded

Lead Length	Inch	Cm
Black	6	15.2
White	6	15.2
Green	NA	NA
Red	6	15.2
Blue	6	15.2
Purple	7.1	18
Pink	7.1	18

Enclosure

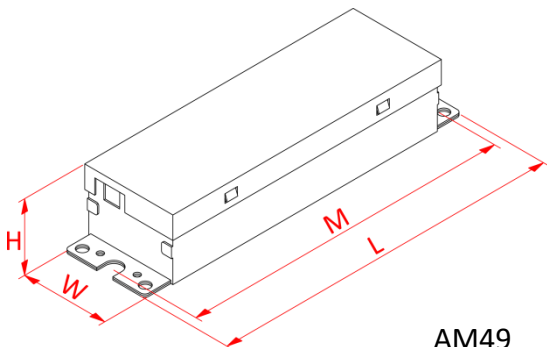

AM49

Enclosure	Inch	Cm
Length(L)	6.22	15.8
Width(W)	1.73	4.4
Height(H)	1.22	3.1
Mounting(M)	5.87	14.9