



Model Name	AC2300S100D
Output Model	Constant Current
Input Voltage	120-277 Vac
Input Frequency	50/60 Hz
Dimming	3 in 1 (PWM,1-10V,Resistance) 10-100% Dimming
Surge Rating	2KV
Warranty	5 Years $TC \leq 75^{\circ}C$ 3 Years $75^{\circ}C \leq TC \leq 90^{\circ}C$

Product Specification



Output Power (W)	Output Voltage (V)	Output Current (A)	Start Temp. ($^{\circ}F/^{\circ}C$)	Tcase Temp. ($^{\circ}F/^{\circ}C$)	Input Current (A)	Input Power (W)	Inrush Current (A)	THD (%)	Power Factor	Efficiency (%)
Max. 100	26-43	2.3	Min. -40/-40	Max. 194/90	0.95@120V 0.41@277V	112	Max. 40	Max. 20	Min. 0.9	Typ. 89

Wire Diagram

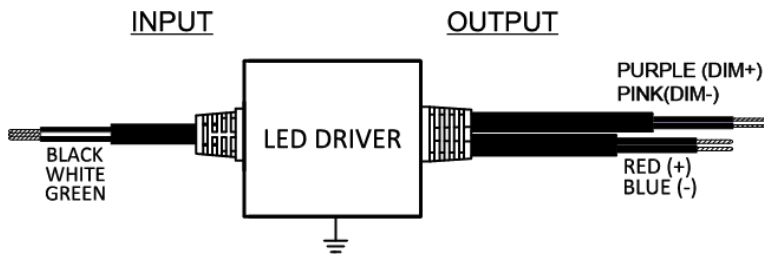

Maximum Wiring Distance (at full load) is 18AWG/18Feet
LED case should be grounded

Lead Length	Inch	Cm
Black	5.9	15
White	5.9	15
Green	5.9	15
Red	5.9	15
Blue	5.9	15
Purple	7.1	18
Pink	7.1	18

Enclosure

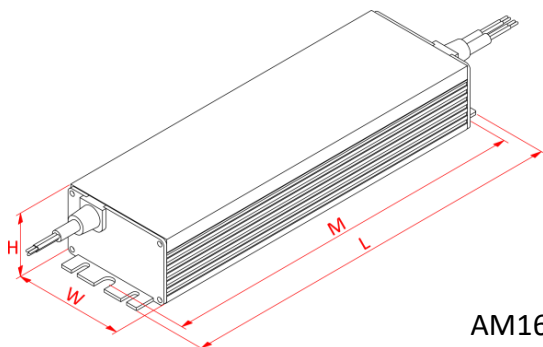

AM168

Enclosure	Inch	Cm
Length(L)	9.5	24.1
Width(W)	2.7	6.8
Height(H)	1.6	4.05
Mounting(M)	8.9	22.6