



Model Name	UFO-3C2800S100DL
Output Model	Constant Current
Input Voltage	347 Vac
Input Frequency	50/60 Hz
Dimming	3 in 1 (PWM,1-10V,Resistance) 10-100% Dimming
Surge Rating	2KV
Warranty	5 Years $TC \leq 75^{\circ}C$ 3 Years $75^{\circ}C \leq TC \leq 90^{\circ}C$

Product Specification



ClassP Type HL

Output Power (W)	Output Voltage (V)	Output Current (A)	Start Temp. ($^{\circ}F/^{\circ}C$)	Tcase Temp. ($^{\circ}F/^{\circ}C$)	Input Current (A)	Input Power (W)	Inrush Current (A)	THD (%)	Power Factor	Efficiency (%)
Max. 100	21-36	2.8	Min. -40/-40	Max. 194/90	0.33@347V	115	Max. 45	Max. 20	Min. 0.9	Typ. 89

Wire Diagram

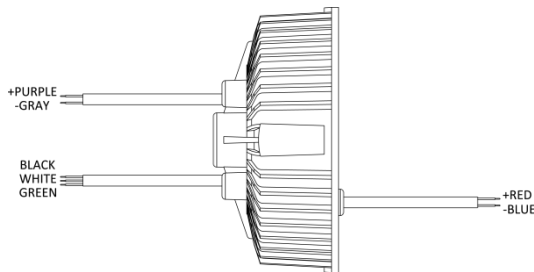

Maximum Wiring Distance (at full load) is 18AWG/18Feet
LED case should be grounded

Lead Length	Inch	Cm
Black	11.8	30
White	11.8	30
Green	11.8	30
Red	7.87	20
Blue	7.87	20
Purple	7.1	18
Gray	7.1	18

Enclosure

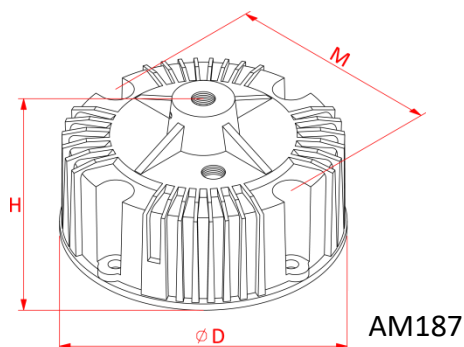

Enclosure	Inch	Cm
Length(L)	5.2	13.2
Width(W)	NA	NA
Height(H)	2.83	7.2
Mounting(M)	4.45	11.3