



<b>Model Name</b>	TAV24S60
<b>Output Mode</b>	Constant Voltage
<b>Input Voltage</b>	120-277 Vac
<b>Input Frequency</b>	50/60 Hz
<b>Dimming</b>	Leading & Trailing Edge Supports 120VAC input exclusively
<b>Surge Rating</b>	1KV
<b>Warranty</b>	5 Years $TC \leq 75^{\circ}C$ 3 Years $75^{\circ}C \leq TC \leq 90^{\circ}C$

## Product Specification



Output Power (W)	Output Voltage (V)	Output Current (A)	Start Temp. ( $^{\circ}F/^{\circ}C$ )	Tcase Temp. ( $^{\circ}F/^{\circ}C$ )	Input Current (A)	Input Power (W)	Inrush Current (A)	THD (%)	Power Factor	Efficiency (%)
Max. 60	24	0.25-2.5	Min 32/0	Max. 194/90	0.59@120V 0.25@277V	70	Max. 30	Max. 20	Min. 0.9	Typ. 86

## Wire Diagram

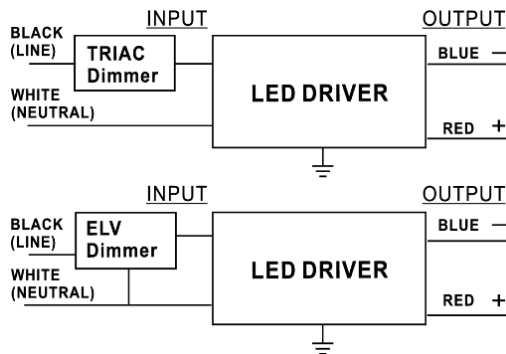

Lead Length	Inch	Cm
Black	6	15.2
White	6	15.2
Red	6	15.2
Blue	6	15.2

Maximum Wiring Distance (at full load) is 18AWG/18Feet

LED case should be grounded

## Enclosure

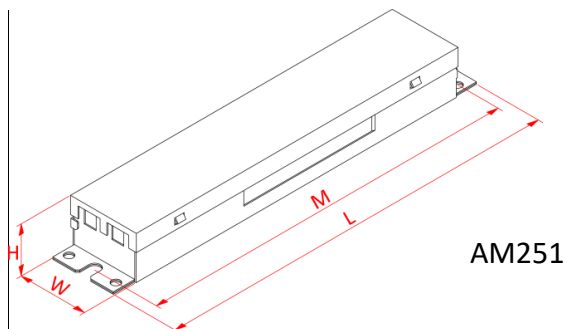

AM251

Enclosure	Inch	Cm
Length(L)	9.5	24.1
Width(W)	1.7	4.3
Height(H)	1.16	2.95
Mounting(M)	8.9	22.6



## Dimmer Compatibility Chart

Dimmer Compatibility Chart for 120VAC/60Hz					
LUTRON	DVCL-153P-WH	LUTRON	SCL-153P-WH	LUTRON	LECL-150H
LUTRON	CTCL-150-LA	LEVITON	IPL06	LEVITON	DSE06
LEVITON	6674N				