



Model Name	T1V12S30
Output Mode	Constant Voltage
Input Voltage	120 Vac
Input Frequency	50/60 Hz
Dimming	Leading & Trailing Edge
Surge Rating	1KV
Warranty	5 Years $TC \leq 75^{\circ}C$ 3 Years $75^{\circ}C \leq TC \leq 90^{\circ}C$

Product Specification



Output Power (W)	Output Voltage (V)	Output Current (A)	Start Temp. ($^{\circ}F/^{\circ}C$)	Tcase Temp. ($^{\circ}F/^{\circ}C$)	Input Current (A)	Input Power (W)	Inrush Current (A)	THD (%)	Power Factor	Efficiency (%)
Max. 30	12	2.5	Min 32/0	Max. 194/90	0.45@120V	36	Max. 30	Max. 20	Min. 0.5	Typ. 85

Wire Diagram

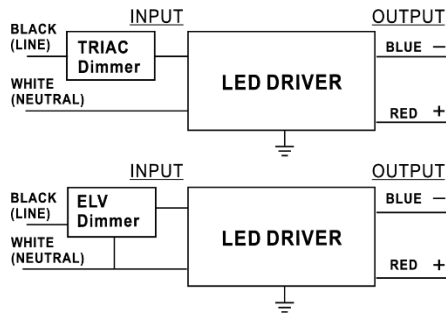

Lead Length	Inch	Cm
Black	6	15.2
White	6	15.2
Green	NA	NA
Red	6	15.2
Blue	6	15.2

Maximum Wiring Distance (at full load) is 18AWG/18Feet

LED case should be grounded

Enclosure

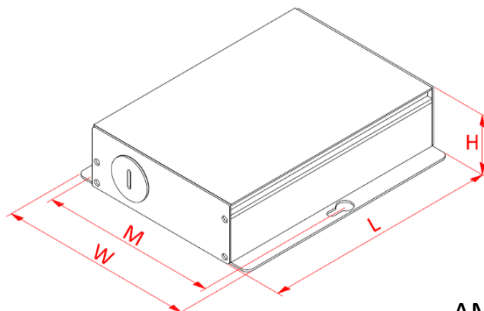

AM205

Enclosure	Inch	Cm
Length(L)	4.96	12.6
Width(W)	4.13	10.5
Height(H)	1.26	3.2
Mounting(M)	3.8	9.6



Dimmer Compatibility Chart

Dimmer Compatibility Chart for 120VAC/60Hz					
LEVITON	RP106	LEVITON	IP106	LUTRON	SF-103P-WH
LEVITON	6633P	LUTRON	CTCL-153P	LUTRON	NTLV-600
LEVITON	6615-POW	LUTRON	DVCL-153P	LUTRON	S-600P-WH
LUTRON	DV-103P	LEVITON	6674	LEVITON	6684
LUTRON	DVPDC-203P	LUTRON	NTELV-300	LUTRON	DVELV-300P