



<b>Model Name</b>	MC1500S63DL
<b>Output Mode</b>	Constant Current
<b>Input Voltage</b>	120-347 Vac
<b>Input Frequency</b>	50/60 Hz
<b>Dimming</b>	3 in 1 (PWM,1-10V,Resistance) 1-100% Dimming
<b>Surge Rating</b>	2KV
<b>Warranty</b>	5 Years $TC \leq 75^{\circ}C$ 3 Years $75^{\circ}C \leq TC \leq 90^{\circ}C$

## Product Specification



Output Power (W)	Output Voltage (V)	Output Current (A)	Start Temp. ( $^{\circ}F/^{\circ}C$ )	Tcase Temp. ( $^{\circ}F/^{\circ}C$ )	Input Current (A)	Input Power (W)	Inrush Current (A)	THD (%)	Power Factor	Efficiency (%)
Max. 63	25-42	1.0-1.5	Min. -40/-40	Max. 194/90	0.6@120V 0.21@347V	73	Max. 30A	Max. 20	Min. 0.9	Typ. 86

## Wire Diagram

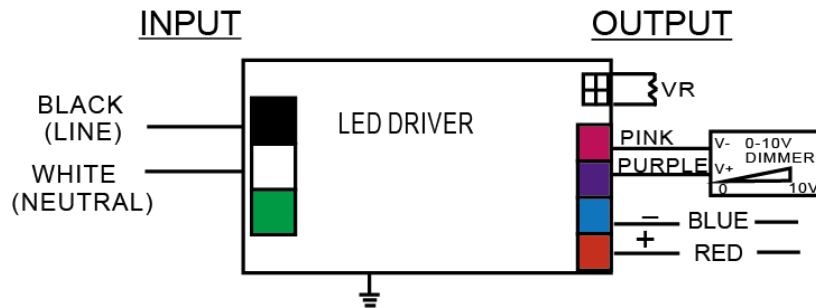

Maximum wiring distance (at full load) is 18AWG/18Feet  
LED case should be grounded

## Enclosure

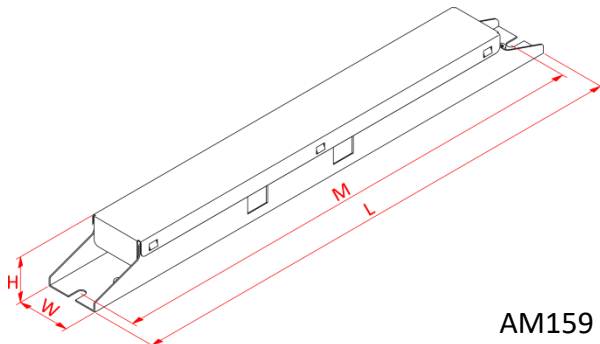

AM159

Enclosure	Inch	Cm
Length(L)	12.4	31.4
Width(W)	1.3	3.4
Height(H)	1.08	2.75
Mounting(M)	11.9	30.1