



Model Name	R3C1500S54D
Output Model	Constant Current
Input Voltage	347 Vac
Input Frequency	50/60 Hz
Dimming	3 in 1 (PWN,1-10V,Resistance) 1-100% Dimming
Surge Rating	2KV
Warranty	5 Years $TC \leq 75^{\circ}C$ 3 Years $75^{\circ}C \leq TC \leq 90^{\circ}C$

Product Specification



**Type TL
Class2**

Output Power (W)	Output Voltage (V)	Output Current (A)	Start Temp. ($^{\circ}F/^{\circ}C$)	Tcase Temp. ($^{\circ}F/^{\circ}C$)	Input Current (A)	Input Power (W)	Inrush Current (A)	THD (%)	Power Factor	Efficiency (%)
Max. 54	27-55	0.9-1.5	Min. -40/-40	Max. 194/90	0.21@347V	61	Max. 25A	Max. 20	Min. 0.9	Typ. 88

Wire Diagram

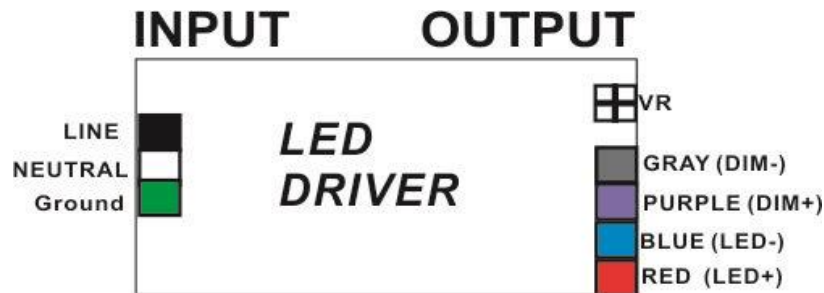

Maximum wiring distance (at full load) is 18AWG/18Feet
LED case should be grounded

Enclosure

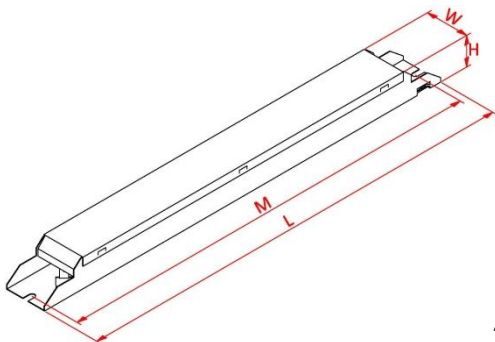

AM191

Enclosure	Inch	Cm
Length(L)	11.9	30.3
Width(W)	1.2	3
Height(H)	0.87	2.2
Mounting(M)	11.5	29.3