



<b>Model Name</b>	AV48S200D
<b>Output Mode</b>	Constant Voltage
<b>Input Voltage</b>	120-277 Vac
<b>Input Frequency</b>	50/60 Hz
<b>Dimming</b>	3 in 1 ( PWM, 1-10V, Resistance) Dimming: 10-100%
<b>Surge Rating</b>	2KV
<b>Warranty</b>	5 Years $TC \leq 75^{\circ}C$ 3 Years $75^{\circ}C \leq TC \leq 90^{\circ}C$

## Product Specification



Output Power (W)	Output Voltage (V)	Output Current (A)	Start Temp. (°F/°C)	Tcase Temp. (°F/°C)	Input Current (A)	Input Power (W)	Inrush Current (A)	THD (%)	Power Factor	Efficiency (%)
Max. 200	48	0.416-4.16	Min -40/-40	Max. 194/90	1.84@120V 0.8@277V	220	Max. 50	Max. 20	Min. 0.9	Typ. 91

## Wire Diagram

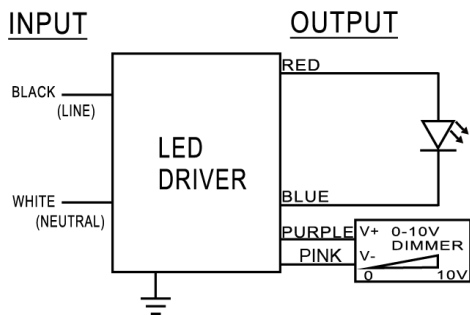

Maximum Wiring Distance (at full load) is 18AWG/18Feet

LED case should be grounded

The driver is suitable for pure LED load only

Lead Length	Inch	Cm
Black	6	15.2
White	6	15.2
Green	NA	NA
Red	6	15.2
Blue	6	15.2
Purple	7.1	18
Pink	7.1	18

## Enclosure

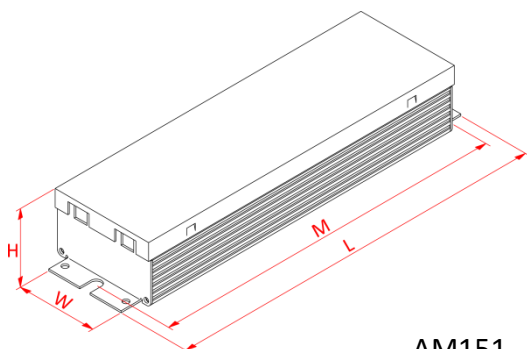

AM151

Enclosure	Inch	Cm
Length(L)	9.5	24.1
Width(W)	2.6	6.6
Height(H)	1.6	4.05
Mounting(M)	8.9	22.6