



Antron Electronics Co.,LTD
安雄電子股份有限公司

Constant Current Emergency LED Driver



Model Name	EMAC10-55 5W
Output Mode	Constant Current
Input Voltage	120-277 Vac
Input Frequency	50/60 Hz
Dimming	N/A
Surge Rating	3KV
Warranty	5 Years TC $\leq 60^{\circ}\text{C}$ 3 Years TC $\leq 66^{\circ}\text{C}$

Product Specification



Output Power (W)	Output Voltage (V)	Output Current (mA)	Operating Duration Time	Operating Temp. (C)	Battery Voltage (V)	Battery Charge Current (mA)	Battery Recharge Time	Input Power	Input Current (mA)
Max. 5	15-55	91	Min. 90min	0-50	6.4	185	Min. 24Hrs	Max. 2.95	Max. 37

Wire Diagram

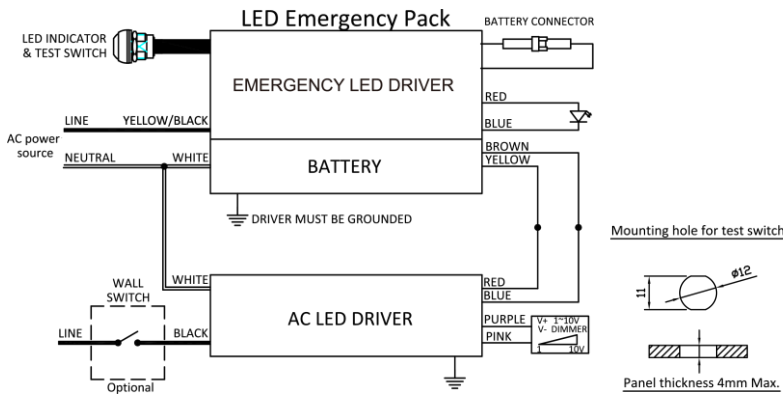

Maximum Wiring Distance (at full load) is 18AWG/18Feet

Lead Length	Inch	Cm
White	22.04	56
Yellow/Black	19.29	49
Red	25.98	66
Blue	25.98	66
Yellow	32.28	82
Brown	32.28	82
Battery Connector	33.07	84
Test Switch	25	63.5
LED Indicator	6	15.24

Enclosure

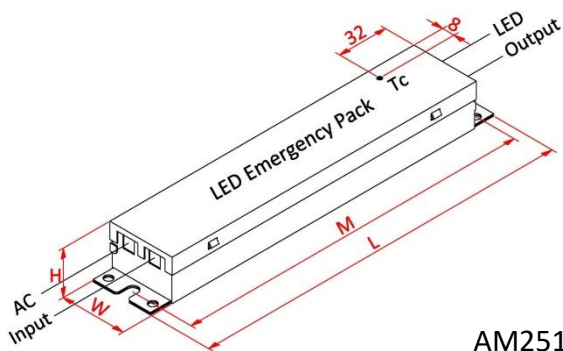







AM251



Enclosure	Inch	Cm
Length(L)	9.5	24.1
Width(W)	1.7	4.3
Height(H)	1.16	2.95
Mounting(M)	8.9	22.6



Input Wiring		
Standard	Isolated Pass Relay	Others
<input type="checkbox"/>	<input type="checkbox"/>	
Power Activate		
Yes <input type="checkbox"/>	No <input type="checkbox"/>	

Output Lead Type			
Standard	Single Conduit	Dual Conduits	Others
<input type="checkbox"/>	<input type="checkbox"/>	<input type="checkbox"/>	

Test Switch				
Type	Black & Red	White & Red	White & Translucent	Metal
Image	 <small>IP 67</small>	 <small>IP 67</small>	 <small>IP 67</small>	 <small>IP 67</small>
	<input type="checkbox"/> Red Light	<input type="checkbox"/> Red Light	<input type="checkbox"/> Red Light	<input type="checkbox"/> Red Light
Type	PVC Wire	Fire-Resistant Wire	R-Mount	Customization
Image				
	<input type="checkbox"/>	<input type="checkbox"/>	<input type="checkbox"/>	<input type="checkbox"/>

Panel				
Type	White	Metal	No Need	Others
Image				
	<input type="checkbox"/>	<input type="checkbox"/>	<input type="checkbox"/>	



Input Specifications

Parameter	Min.	Typ.	Max.	Notes
Input Voltage	108V	120/277V	305V	
Input Current	-	-	0.037A	@120Vac input with full load
Input Frequency	47Hz	60Hz	63Hz	
Leakage Current	-	-	0.7mA	@277Vac input
Turn On Time	-	-	1.0s	@120Vac input at full load
Hold Up Time	-	-	0.1s	@Nominal input and full load
Efficiency	%	%	%	@55Vdc output at full load
Standby Power	-	-	2.95W	

Output Specifications

Parameter	Min.	Typ.	Max.	Notes
Output Voltage	15V	-	55V	
Output Current	-	91mA	-	@55Vdc-@15Vdc
Battery Charge Current		185mA		LiFePO4, 6.4V, 1800mAh
Battery Voltage		6.4V		
Battery Recharge Time			24Hrs	
Emergency Operation	90min			
No-Load Output Voltage	55V	58V	60V	
Rated Current	86mA	91mA	96mA	
Rated Power	-	5W	-	
Output Current Ripple	-	±10%	-	

General Specifications

Parameter	Min.	Typ.	Max.	Notes
MTBF	-	100,000 Hours	-	@25°C ambient temperature
Lifespan Time	75,000 Hours	-	-	In the range of specification required by normal use of the power supply at ambient temperature 55°C
Cold Start	-	-	2.0s	@0°C



Test Switch

Test Switch Operation

With AC power source alive

1. Push and Hold for 2 seconds, the unit will transfer from charge mode to discharge mode, the indicator is OFF.
2. Release the test switch, the unit will back to charge mode automatically, the indicator is ON.

Protection

Parameter	Description
Over Voltage	Output current decay mode, recovers automatically after fault condition is removed.
Short Circuit	Hiccup mode, recovers automatically after fault condition is removed.
Over Temperature	Shut down o/p voltage, re-power on to recover.

Environmental Specifications

Parameter	Min.	Typ.	Max.	Notes
Operation Temperature	0°C	-	50°C	
Storage Temperature	-20°C	-	55°C	
Humidity	10%	-	90%	
T-Case Temperature	-	-	66°C	

Safety and EMC Compliance

Safety Standards	Withstand Voltage	Isolation Resistance	EMC Standards	
			EMI	EMS
UL 924 CSA C22.2 No. 141-15	I/P-O/P: 2.0K Vac I/P-FG: 2.0K Vac O/P-FG: 0.5K Vac	I/P-O/P: I/P-FG: O/P-FG: 100Mohm/500VDC	FCC Part 15 class A	FCC Part 15 class A

Note

- The emergency backup driver shall be installed inside an electrical enclosure. If the application requires the emergency pack to be mounted on top of the luminaire please use Model which provides a metal flexible conduit instead of bare wires.

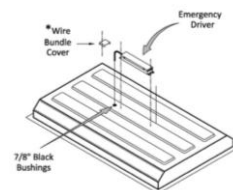



Revision History

Change date	Description of Change		
	Item	From	To
2026/02/25	Model name	EMLEDS10-1555-6.4CHXNB 5W	EMAC10-55 5W