



<b>Model Name</b>	3C2100S84D
<b>Output Model</b>	Constant Current
<b>Input Voltage</b>	347 Vac
<b>Input Frequency</b>	50/60 Hz
<b>Dimming</b>	3 in 1 ( PWM, 1-10V, Resistance) Dimming: 1-100%
<b>Surge Rating</b>	2KV
<b>Warranty</b>	5 Years $TC \leq 75^{\circ}C$ 3 Years $75^{\circ}C \leq TC \leq 90^{\circ}C$

## Product Specification



Output Power (W)	Output Voltage (V)	Output Current (A)	Start Temp. ( $^{\circ}F/^{\circ}C$ )	Tcase Temp. ( $^{\circ}F/^{\circ}C$ )	Input Current (A)	Input Power (W)	Inrush Current (A)	THD (%)	Power Factor	Efficiency (%)
Max. 84	24-40	2.1	Min -40/-40	Max. 194/90	0.28@347V	94	Max. 35	Max. 20	Min. 0.9	Typ. 89

## Wire Diagram

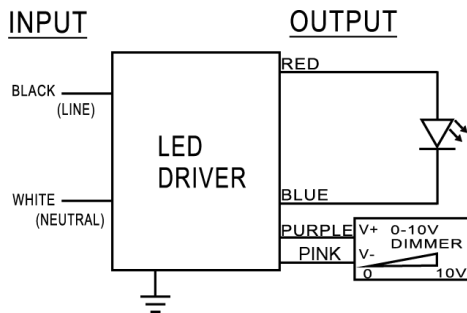

Maximum Wiring Distance (at full load) is 18AWG/18Feet

LED case should be grounded

Lead Length	Inch	Cm
Black	5.9	15
White	5.9	15
Green	NA	NA
Red	5.9	15
Blue	5.9	15
Purple	7.1	18
Pink	7.1	18

## Enclosure

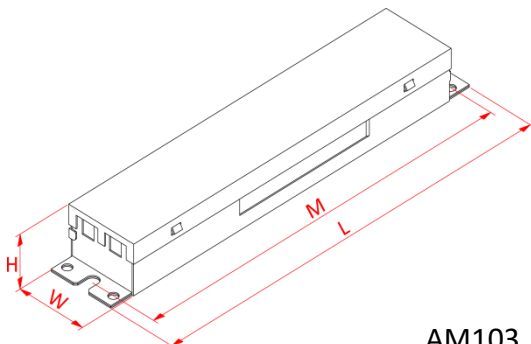

AM103

Enclosure	Inch	Cm
Length(L)	9.5	24.1
Width(W)	1.7	4.3
Height(H)	1.2	3.05
Mounting(M)	8.9	22.6