



Model Name	AC700D30CBL
Output Model	Constant Current
Input Voltage	120-277 Vac
Input Frequency	50/60 Hz
Dimming	Control Color Temperature and Brightness via 2 Dimmers
Surge Rating	2KV
Warranty	5 Years $TC \leq 75^{\circ}C$ 3 Years $75^{\circ}C \leq TC \leq 90^{\circ}C$

Product Specification



ClassP Class2

Output Power (W)	Output Voltage (V)	Output Current (A)	Start Temp. ($^{\circ}F/^{\circ}C$)	Tcase Temp. ($^{\circ}F/^{\circ}C$)	Input Current (A)	Input Power (W)	Inrush Current (A)	THD (%)	Power Factor	Efficiency (%)
Max. 30	27-45	0.7	Min. -40/-40	Max. 194/90	0.3@120V 0.13@277V	35	Max. 30	Max. 20	Min. 0.9	Typ. 85

Wire Diagram

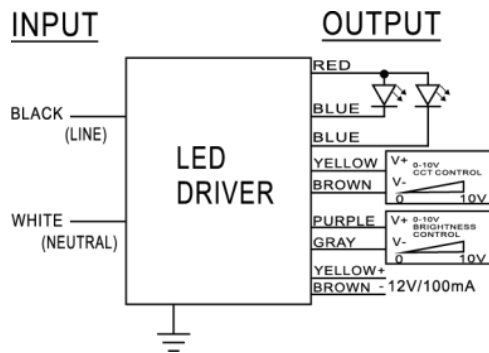

Maximum Wiring Distance (at full load) is 18AWG/18Feet

LED case should be grounded

Lead Length	Inch	Cm
Black	5.9	15
White	5.9	15
Green	NA	NA
Red	5.9	15
Blue	5.9	15
Purple	7.1	18
Gray	7.1	18
Yellow	7.1	18
Brown	7.1	18

Enclosure

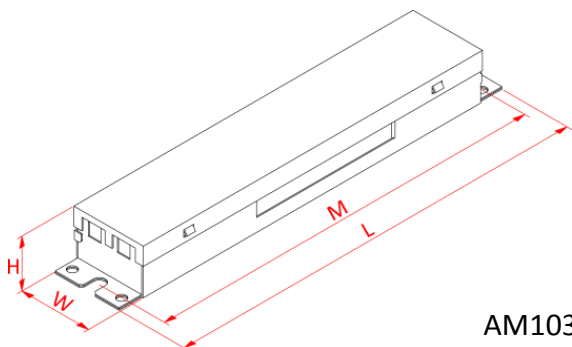

AM103

Enclosure	Inch	Cm
Length(L)	9.5	24.1
Width(W)	1.7	4.3
Height(H)	1.14	2.9
Mounting(M)	8.9	22.6