



Constant Power Emergency LED Driver



Model Name	4EMLEDS30-50255-25.6CHPNB
Output Mode	Constant Power
Input Voltage	347-480 Vac
Input Frequency	50/60 Hz
Dimming	N/A
Surge Rating	3KV
Warranty	5 Years TC $\leq 60^{\circ}\text{C}$ 3 Years TC $\leq 70^{\circ}\text{C}$

Product Specification



Output Power (W)	Output Voltage (V)	Output Current (mA)	Operating Duration Time	Operating Temp. ($^{\circ}\text{C}$)	Battery Voltage (V)	Battery Charge Current (mA)	Battery Charge Time	Input Power (W)	Input Current (mA)
Max. 30	50-255	600-118	Min. 90min	0-55	25.6	350	Min. 24Hrs	Max. 14	Max. 130

Wire Diagram

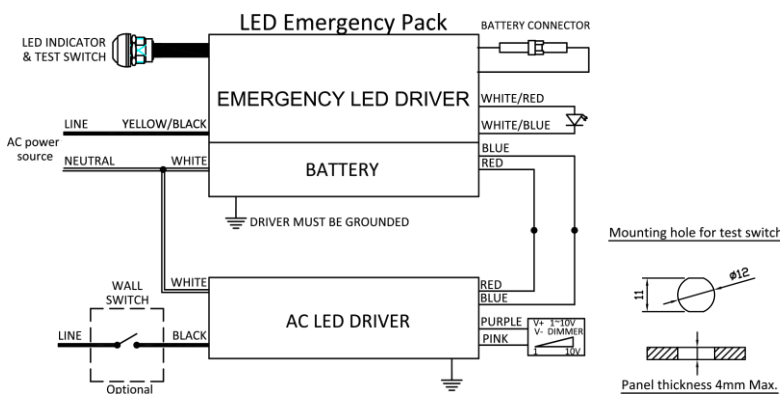

Maximum Wiring Distance (at full load) is 18AWG/18Feet

Lead Length	Inch	Cm
White	22.04	56
Yellow/Black	19.29	49
White/Red	25.98	66
White/Blue	25.98	66
Red	32.28	82
Blue	32.28	82
Battery Connector	33.07	84
Test Switch	25	63.5
LED Indicator	6	15.2

Enclosure

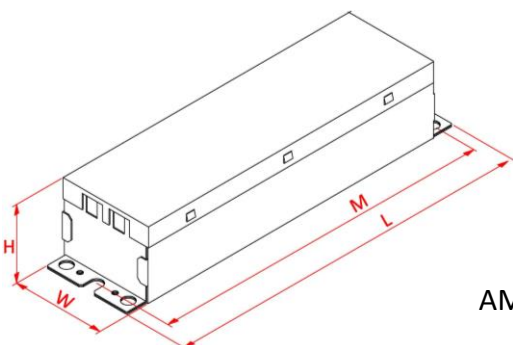

AM247

Enclosure	Inch	Cm
Length(L)	12.6	32
Width(W)	2.24	5.7
Height(H)	2.05	5.2
Mounting(M)	12	30.5



Input Specifications

Parameter	Min.	Typ.	Max.	Notes
Input Voltage	312V	347/480V	528V	
Input Current	-	-	0.13A	@347Vac input with full load
Input Frequency	47Hz	60Hz	63Hz	
Leakage Current	-	-	0.7mA	@480Vac input
Turn On Time	-	-	1.0s	@347Vac input at full load
Hold Up Time	-	-	0.1s	@Nominal input and full load
Efficiency	85%	86%	87%	@255Vdc output at full load
Standby Power	-	-	14W	

Output Specifications

Parameter	Min.	Typ.	Max.	Notes
Output Voltage	50V	-	255V	
Output Current	118mA	-	600mA	@255Vdc-@50Vdc
Battery Charge Current	250mA	350mA	400mA	LiFePO4, 25.6V, 3000mAh
Battery Voltage	-	25.6V	-	
Battery Charge Time	-	-	24Hrs	
Emergency Operation	90min	-	-	
No-Load Output Voltage	260V	265V	275V	
Rated Current	118mA	-	600mA	
Rated Power	-	30W	-	
Output Current Ripple	-	±10%	-	

General Specifications

Parameter	Min.	Typ.	Max.	Notes
MTBF	-	100,000 Hours	-	@25°C ambient temperature
Lifespan Time	75,000 Hours	-	-	In the range of specification required by normal use of the power supply at ambient temperature 55°C
Cold Start	-	-	2.0s	@0°C



Test Switch

Test Switch Operation

With AC power source alive

1. Push and Hold for 2 seconds, the unit will transfer from charge mode to discharge mode, the indicator is OFF.
2. Release the test switch, the unit will back to charge mode automatically, the indicator is ON.

Protection

Parameter	Description
Over Voltage	Output current decay mode, recovers automatically after fault condition is removed.
Short Circuit	Hiccup mode, recovers automatically after fault condition is removed.
Over Temperature	Shut down o/p voltage, re-power on to recover.

Environmental Specifications

Parameter	Min.	Typ.	Max.	Notes
Operation Temperature	0°C	-	55°C	
Storage Temperature	-20°C	-	55°C	
Humidity	10%	-	90%	
T-Case Temperature	-	-	70°C	

Safety and EMC Compliance

Safety Standards	Withstand Voltage	Isolation Resistance	EMC Standards	
			EMI	EMS
UL 924 CSA C22.2 NO. 141-15	I/P-O/P: 2.0K Vac I/P-FG: 2.0K Vac O/P-FG: 0.5K Vac	I/P-O/P: I/P-FG: O/P-FG: 100Mohm/500VDC	FCC Part 15 class A	FCC Part 15 class A

Note

- The emergency backup driver shall be installed inside an electrical enclosure. If the application requires the emergency pack to be mounted on top of the luminaire, please use model which provides a metal flexible conduit instead of bare wires.

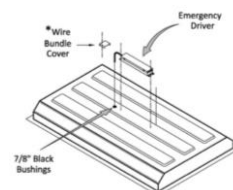



Battery Current V.S. Time

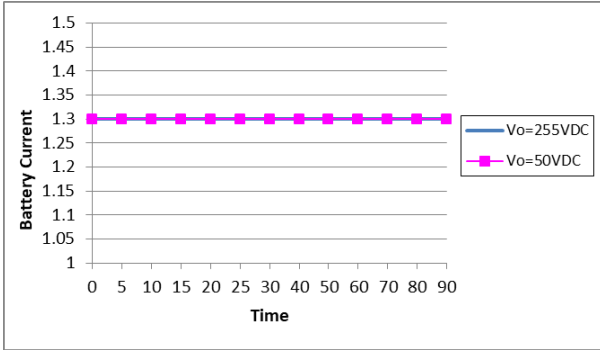

Battery Voltage V.S. Time

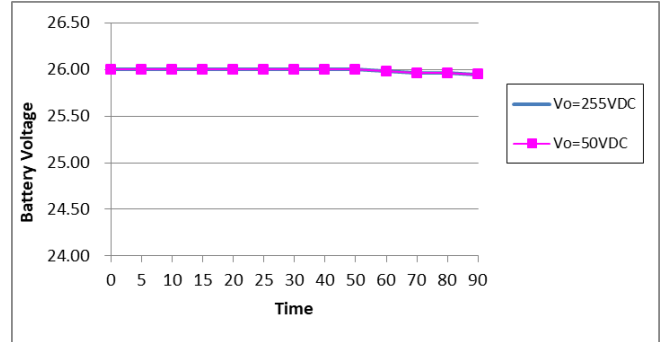

EMB Efficiency V.S. Time

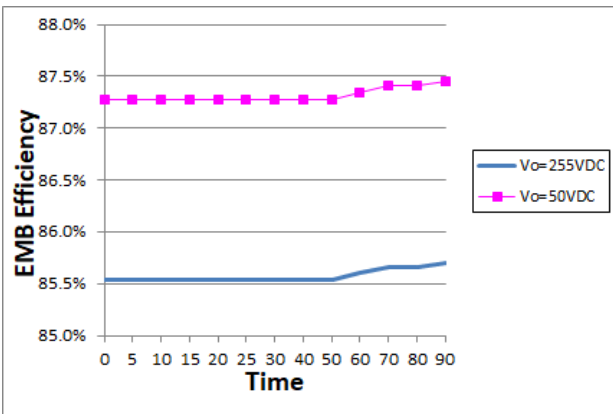

EMB Output Power V.S. LED Voltage

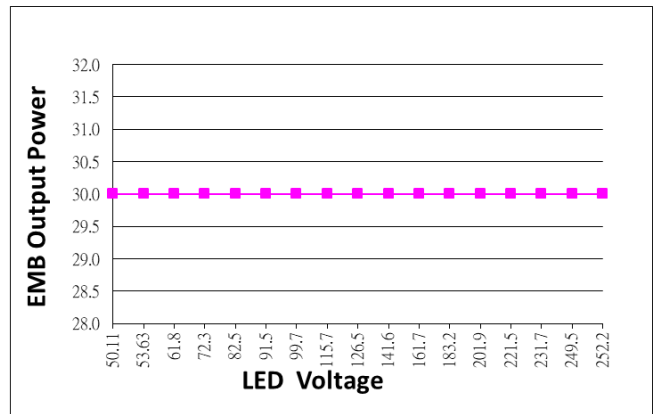

EMB Output Power V.S. Time

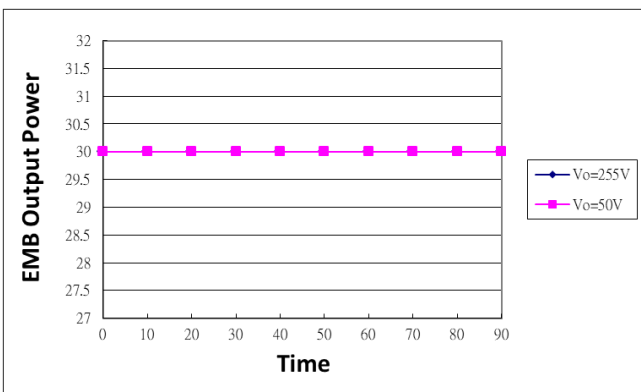

EMB Output Current V.S. LED Voltage

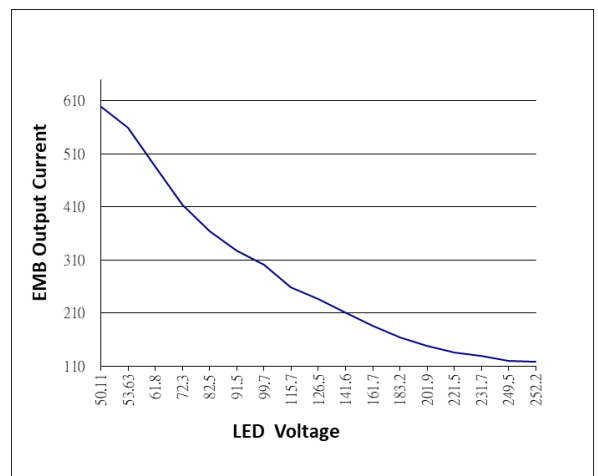

Data is based upon tests performed by Antron Electronics in a controlled environment and representative performance. Actual performance can vary depending on operating conditions. Specifications are subject to change without notice. All specifications are nominal unless otherwise noted.