



# Constant Power Emergency LED Driver



<b>Model Name</b>	MEMLEDS30-1555-9.6CHPNB-FT
<b>Output Mode</b>	Constant Power
<b>Input Voltage</b>	120-347 Vac
<b>Input Frequency</b>	50/60 Hz
<b>Dimming</b>	N/A
<b>Surge Rating</b>	3KV
<b>Warranty</b>	5 Years $T_C \leq 60^\circ C$ 3 Years $T_C \leq 70^\circ C$

## Product Specification



Output Power (W)	Output Voltage (V)	Output Current (mA)	Operating Duration Time	Operating Temp. ( $^\circ C$ )	Battery Voltage (V)	Battery Charge Current (mA)	Battery Charge Time	Input Power (W)	Input Current (mA)
Typ. 30	15-55	2000-545	Min. 90min	0-55	9.6	450	Min. 24Hrs	Max. 11	Max. 130

## Wire Diagram

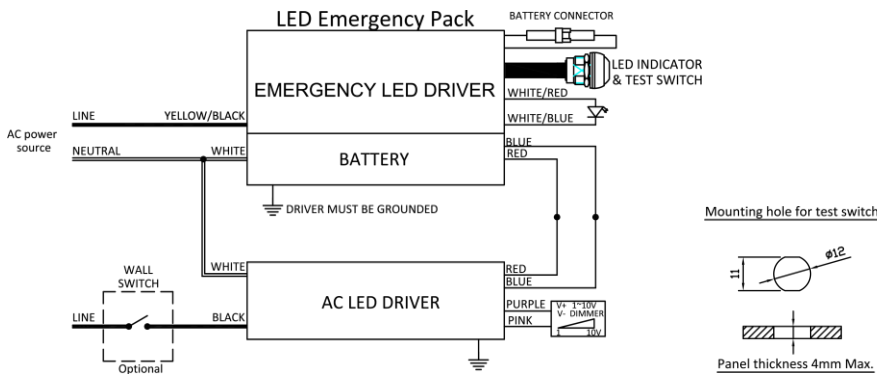

Maximum Wiring Distance (at full load) is 18AWG/18Feet

Lead Length	Inch	Cm
White	30.7	78
Yellow/Black	30.7	78
White/Red	30.7	78
White/Blue	30.7	78
Red	30.7	78
Blue	30.7	78
Battery Connector	33.07	84
Test Switch	25	63.5
LED Indicator	6	15.2

## Enclosure

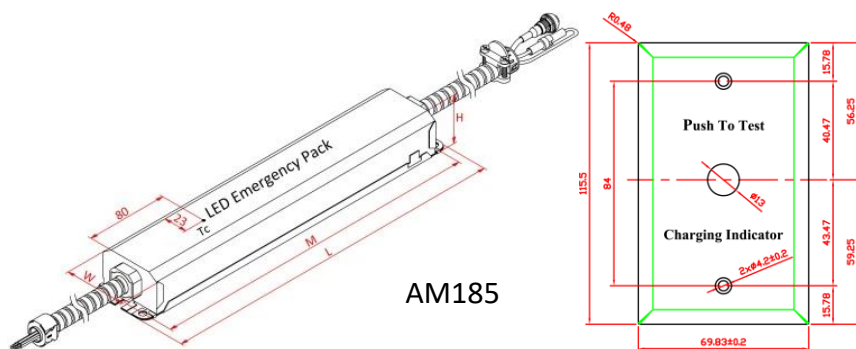

Enclosure	Inch	Cm
Length(L)	13.3	33.8
Width(W)	2.44	6.2
Height(H)	1.49	3.8
Mounting(M)	12.68	32.2



## Input Specifications

Parameter	Min.	Typ.	Max.	Notes
Input Voltage	108V	120/347V	382V	
Input Current	-	-	0.13A	@120Vac input with full load
Input Frequency	47Hz	60Hz	63Hz	
Leakage Current	-	-	0.7mA	@347Vac input
Turn On Time	-	-	1.0s	@120Vac input at full load
Hold Up Time	-	-	0.1s	@Nominal input and full load
Efficiency	80%	83%	85%	@55Vdc output at full load
Standby Power	-	-	11W	

## Output Specifications

Parameter	Min.	Typ.	Max.	Notes
Output Voltage	15V	-	55V	
Output Current	545mA	-	2000mA	@55Vdc-@15Vdc
Battery Charge Current		450mA		LiFePO4, 9.6V, 6600mAh
Battery Voltage		9.6V		
Battery Charge Time			24Hrs	
Emergency Operation	90min			
No-Load Output Voltage	55V	58V	60V	
Rated Current	545mA	-	2000mA	
Rated Power	-	30W	-	
Output Current Ripple	-	±10%	-	

## General Specifications

Parameter	Min.	Typ.	Max.	Notes
MTBF	-	100,000 Hours	-	@25°C ambient temperature
Lifespan Time	75,000 Hours	-	-	In the range of specification required by normal use of the power supply at ambient temperature 55°C
Cold Start	-	-	2.0s	@0°C



## Test Switch

### Test Switch Operation

With AC power source alive

1. Push and Hold for 2 seconds, the unit will transfer from charge mode to discharge mode, the indicator is OFF.
2. Release the test switch, the unit will back to charge mode automatically, the indicator is ON.

## Protection

Parameter	Description
Over Voltage	Output current decay mode, recovers automatically after fault condition is removed.
Short Circuit	Hiccup mode, recovers automatically after fault condition is removed.
Over Temperature	Shut down o/p voltage, re-power on to recover.

## Environmental Specifications

Parameter	Min.	Typ.	Max.	Notes
Operation Temperature	0°C	-	55°C	
Storage Temperature	-20°C	-	55°C	
Humidity	10%	-	90%	
T-Case Temperature	-	-	70°C	

## Safety and EMC Compliance

Safety Standards	Withstand Voltage	Isolation Resistance	EMC Standards	
			EMI	EMS
UL 924 CSA C22.2 No. 141-15	I/P-O/P: 2.0K Vac I/P-FG: 2.0K Vac O/P-FG: 0.5K Vac	I/P-O/P: I/P-FG: O/P-FG: 100Mohm/500VDC	FCC Part 15 class A	FCC Part 15 class A

## Note

- The emergency backup driver shall be installed inside an electrical enclosure. If the application requires the emergency pack to be mounted on top of the luminaire please use Model which provides a metal flexible conduit instead of bare wires.

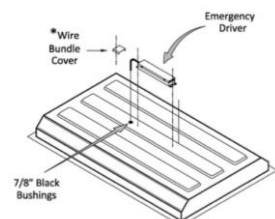



### Battery Current V.S. Time

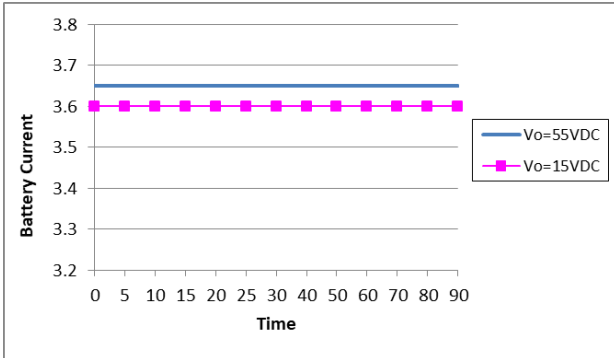

### Battery Voltage V.S. Time

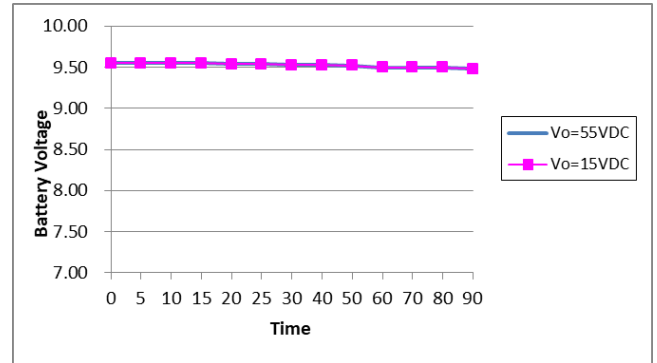

### EMB Efficiency V.S. Time

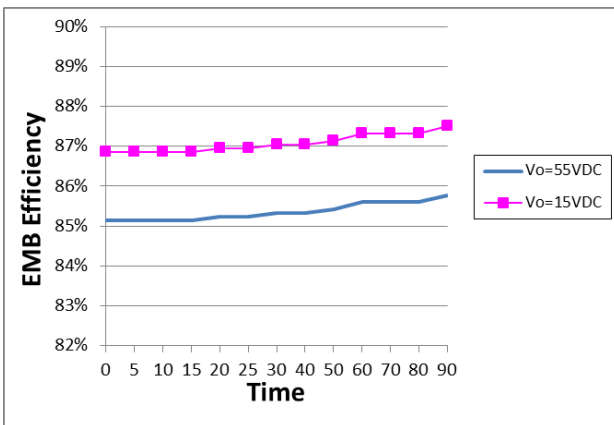

### EMB Output Power V.S. LED Voltage

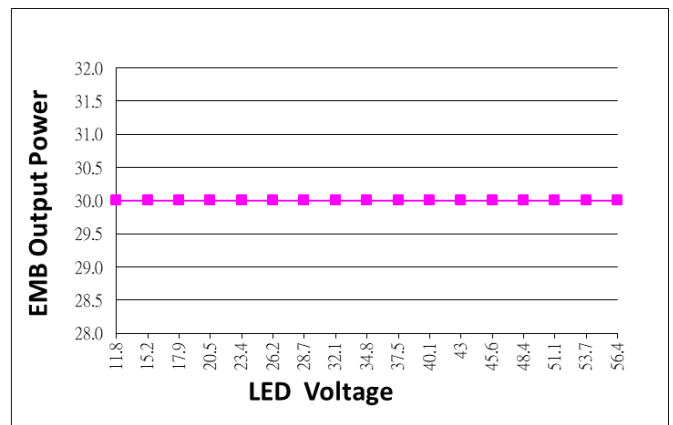

### EMB Output Power V.S. Time

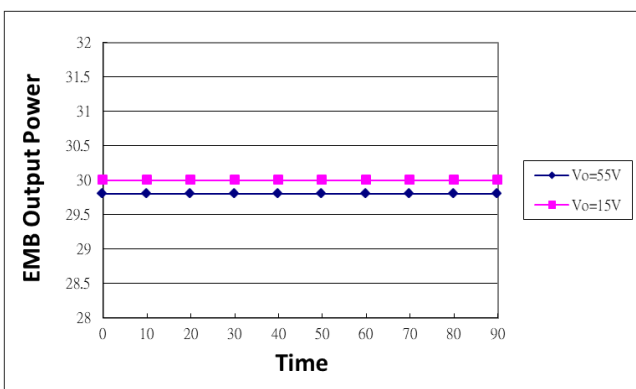

### EMB Output Current V.S. LED Voltage

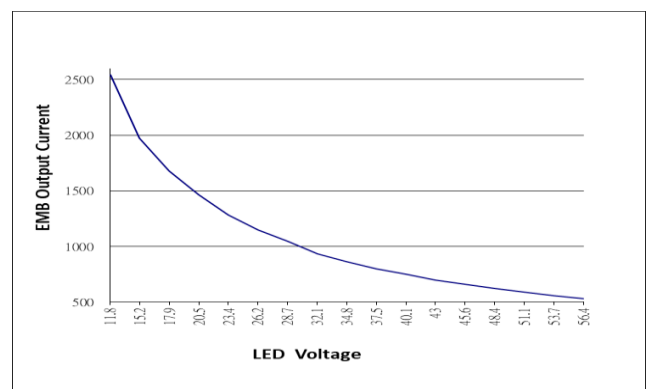

Data is based upon tests performed by Antron Electronics in a controlled environment and representative performance. Actual performance can vary depending on operating conditions. Specifications are subject to change without notice. All specifications are nominal unless otherwise noted.