



Self-Diagnostic Emergency LED Driver



Model Name	SDEMAP10-55
Output Mode	Constant Power
Input Voltage	120-277 Vac
Input Frequency	50/60 Hz
Dimming	N/A
Surge Rating	3KV
Warranty	5 Years TC $\leq 60^{\circ}\text{C}$ 3 Years TC $\leq 66^{\circ}\text{C}$

Product Specification



Output Power (W)	Output Voltage (V)	Output Current (mA)	Operating Duration Time	Operating Temp. ($^{\circ}\text{C}$)	Battery Voltage (V)	Battery Charge Current (mA)	Battery Recharge Time	Input Power	Input Current (mA)
Typ. 10	15-55	660-180	Min. 90min	0-55	6.4	250	Min. 24Hrs	Max. 10	Max. 110

Wire Diagram

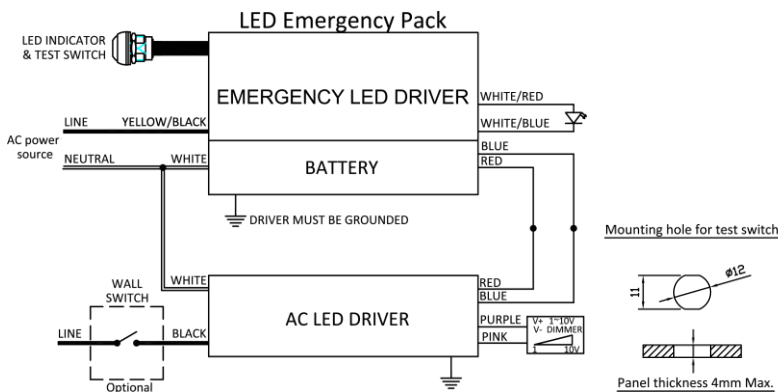

Maximum Wiring Distance (at full load) is 18AWG/18Feet

Lead Length	Inch	Cm
White	22.04	56
Yellow/Black	19.29	49
White/Red	25.98	66
White/Blue	25.98	66
Red	32.28	82
Blue	32.28	82
Test Switch	25	63.5
LED Indicator	6	15.2

Enclosure

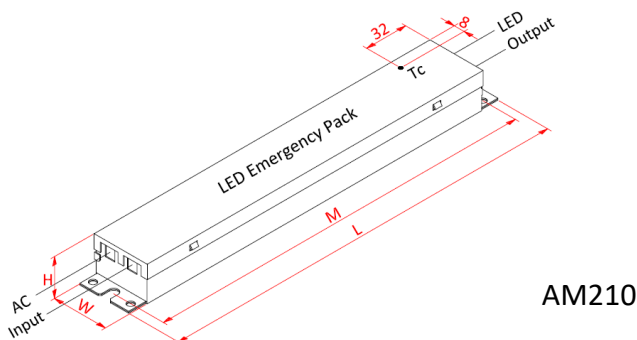







Enclosure	Inch	Cm
Length(L)	11.97	30.4
Width(W)	1.7	4.3
Height(H)	1.2	3.05
Mounting(M)	11.38	28.9



Input Wiring		
Standard	Isolated Pass Relay	Others
<input type="checkbox"/>	<input type="checkbox"/>	
Power Activate		
Yes <input type="checkbox"/>	No <input type="checkbox"/>	

Output Lead Type			
Standard	Single Conduit	Dual Conduits	Others
<input type="checkbox"/>	<input type="checkbox"/>	<input type="checkbox"/>	

Test Switch				
Type	White & Translucent	PVC Wire	Fire-Resistant Wire	R-Mount
Image				
	<input type="checkbox"/> Bi-Color Green & Red	<input type="checkbox"/>	<input type="checkbox"/>	<input type="checkbox"/>
Type	Customization			
Remark				

Panel				
Type	White	Metal	No Need	Others
Image				
	<input type="checkbox"/>	<input type="checkbox"/>	<input type="checkbox"/>	



Power Activate Function

The Power Activate function is created to eliminate the physical battery connector. Traditionally, manufacturer will need to disconnect the physical battery connector to avoid any unwanted energy lose. Now, with the Power Activate function, manufacturer can set the emergency unit to “Sleep Mode” as the last step of assembly process. Once the overall installation is finished on the job site, the emergency unit will automatically activate by AC power, then go to charge mode.

Self-Diagnostic and Self-Testing Function

The emergency driver with self-diagnostic function is designed to automatically operate a 30 seconds short-term test each month, and a 90 minutes duration test every 12 months. The emergency unit will perform the condition via bi-color LED indicator, please refer to the self-diagnostic code table as below:

Self-Diagnostic Code Table

EMB Status	LED Indication	Condition	Failure Priority
Normal Mode	Steady GREEN	Battery is Fully Charged	N/A
	Flash GREEN	Battery is Charging	N/A
Emergency Mode	One RED Flash	Charging Failure	1
	Two RED Flashes	Battery Failure	2
	Three RED Flashes	Load Failure	3

Note:

1. The failure code occurs every 10 seconds. Only highest priority failure is indicated.
2. One Red flash: Battery fail to fully charge in 24 hours.
3. Two Red flash: Battery complete dead or bad battery connection.

Manual Testing

Manual testing can be performed by pressing the test switch. The failure code will be the same as Self-Diagnostic Code Table above. Please follow the Manual Test Sequence Table in blow:

Manual Test Sequence Table

EMB Status	Manual Test Item	Test Switch Operation
Normal Mode	Quick Test	Press and Hold
	30-Second Test	2 x Press and Release
	90-Minute Test	3 x Press and Release
	Cancel 90-Minute Test	1 x Press and Release
Emergency Mode	Sleep Mode	Press and Hold



Input Specifications

Parameter	Min.	Typ.	Max.	Notes
Input Voltage	108V	120/277V	305V	
Input Current	-	-	0.11A	@120Vac input with full load
Input Frequency	47Hz	60Hz	63Hz	
Leakage Current	-	-	0.7mA	@277Vac input
Turn On Time	-	-	1.0s	@120Vac input at full load
Hold Up Time	-	-	0.1s	@Nominal input and full load
Efficiency	85%	86%	87%	@55Vdc output at full load
Standby Power	-	-	10W	

Output Specifications

Parameter	Min.	Typ.	Max.	Notes
Output Voltage	15V	-	55V	
Output Current	180mA	-	660mA	@55Vdc-@15Vdc
Battery Charge Current	-	250mA	-	LiFePO4, 6.4V, 3600mAh
Battery Voltage	-	6.4V	-	
Battery Recharge Time	-	-	24Hrs	
Emergency Operation	90min	-	-	
No-Load Output Voltage	55V	58V	60V	
Rated Current	180mA	-	660mA	
Rated Power	-	10W	-	
Output Current Ripple	-	±10%	-	

General Specifications

Parameter	Min.	Typ.	Max.	Notes
MTBF	-	100,000 Hours	-	@25°C ambient temperature
Lifespan Time	75,000 Hours	-	-	In the range of specification required by normal use of the power supply at ambient temperature 55°C
Cold Start	-	-	2.0s	@0°C



Protection

Parameter	Description
Over Voltage	Output current decay mode, recovers automatically after fault condition is removed.
Short Circuit	Hiccup mode, recovers automatically after fault condition is removed.
Over Temperature	Shut down o/p voltage, re-power on to recover.

Environmental Specifications

Parameter	Min.	Typ.	Max.	Notes
Operation Temperature	0°C	-	55°C	
Storage Temperature	-20°C	-	55°C	
Humidity	10%	-	90%	
T-Case Temperature	-	-	66°C	

Safety and EMC Compliance

Safety Standards	Withstand Voltage	Isolation Resistance	EMC Standards	
			EMI	EMS
UL 924 CSA C22.2 NO. 141-15	I/P-O/P: 2.0K Vac I/P-FG: 2.0K Vac O/P-FG: 0.5K Vac	I/P-O/P: I/P-FG: O/P-FG: 100Mohm/500VDC	FCC Part 15 class A	FCC Part 15 class A

Note

- The emergency backup driver shall be installed inside an electrical enclosure. If the application requires the emergency pack to be mounted on top of the luminaire, please use model which provides a metal flexible conduit instead of bare wires.

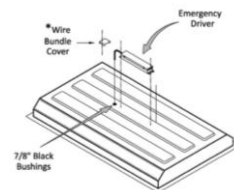



Battery Current V.S. Time

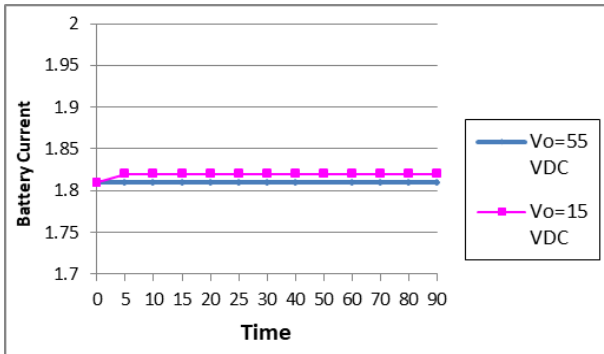

Battery Voltage V.S. Time

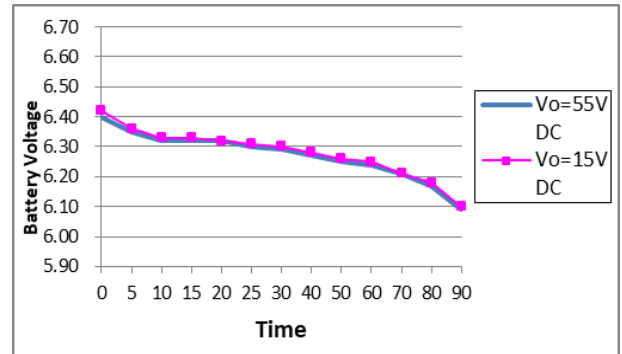

EMB Efficiency V.S. Time

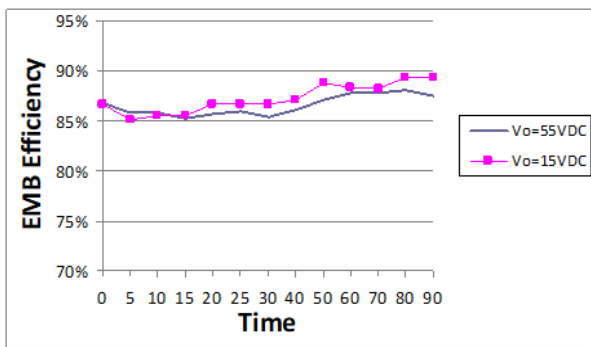

EMB Output Power V.S. LED Voltage

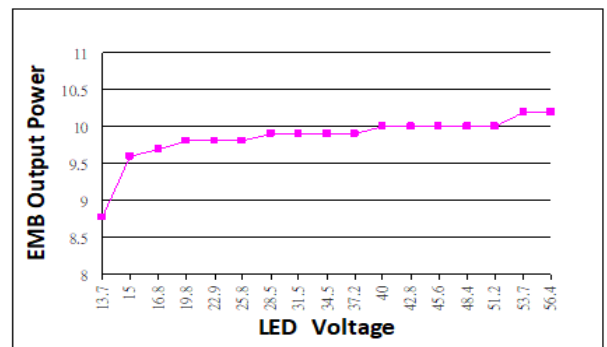

EMB Output Power V.S. Time

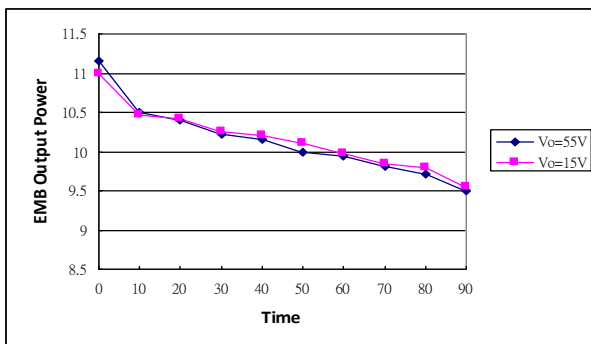

EMB Output Current V.S. LED Voltage

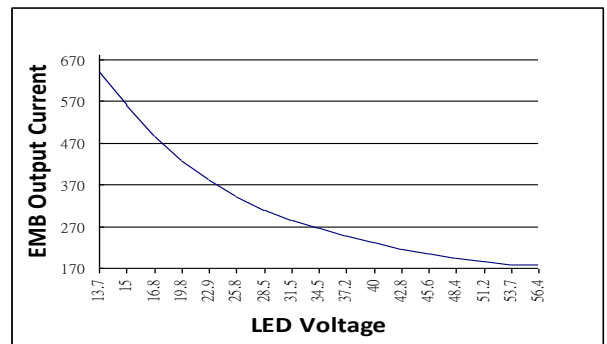

Data is based upon tests performed by Antron Electronics in a controlled environment and representative performance. Actual performance can vary depending on operating conditions. Specifications are subject to change without notice. All specifications are nominal unless otherwise noted.



Revision History

Change date	Description of Change		
	Item	From	To
2025/12/22	Model name	SDLEDS10-1555-6.4CHPNBO	SDEMAP10-55